



# UNIJET 160

**4 kW (50Hz)**  
**4.6 kW (60Hz)**

Per l'aspirazione di fluidi diversi dall'aria non contaminata o a temperature superiori ai 40°C vi preghiamo di contattarci.

*The standard side channel blowers/aspirators are designed to handle clean air up to a maximum of 40°C. Please contact us for special applications.*

Motori costruiti secondo le norme CEI 2-3 (1988) ISOL. CL F PROT. IP 55 e certificati cCSAus

*Motors construction conform with CEI 2-3 (1988) NORMS. ISOL. CL F PROT. IP 55, cCSAus certified*

cCASus file nr. 242079 

	Articolo Item code	kW	V	Hz	assorb. AMP absorbed AMPS	giri/min. r.p.m.	limite servizio max cont. duty S1 (mbar)	dB (A)*	peso (Kg) weight (Kg)
TRIFASE THREE-PHASE	056500	4	200-240 Δ 345-415 Y	50	16.7 Δ 9.7 Y	2900	-345 +440	78	62
	056500	4.6	220-275 Δ 380-480 Y	60	17.6 Δ 10.2 Y	3500	-440 +520	79	62

\* Livello di pressione sonora rilevato secondo le Norme ISO 3746 - 1979 (E). Parametri: r=1 - Rumore di fondo 51 dB (A) - Strumento: Brüel & Kjær type 2232.

\* Sound pressure level tested according to ISO regulation 3746 - 1979 (E). Parameters: r=1 - Background noise 51 dB (A) - Instrument: Brüel & Kjær type 2232.

**dimensioni:**  
**dimensions:**

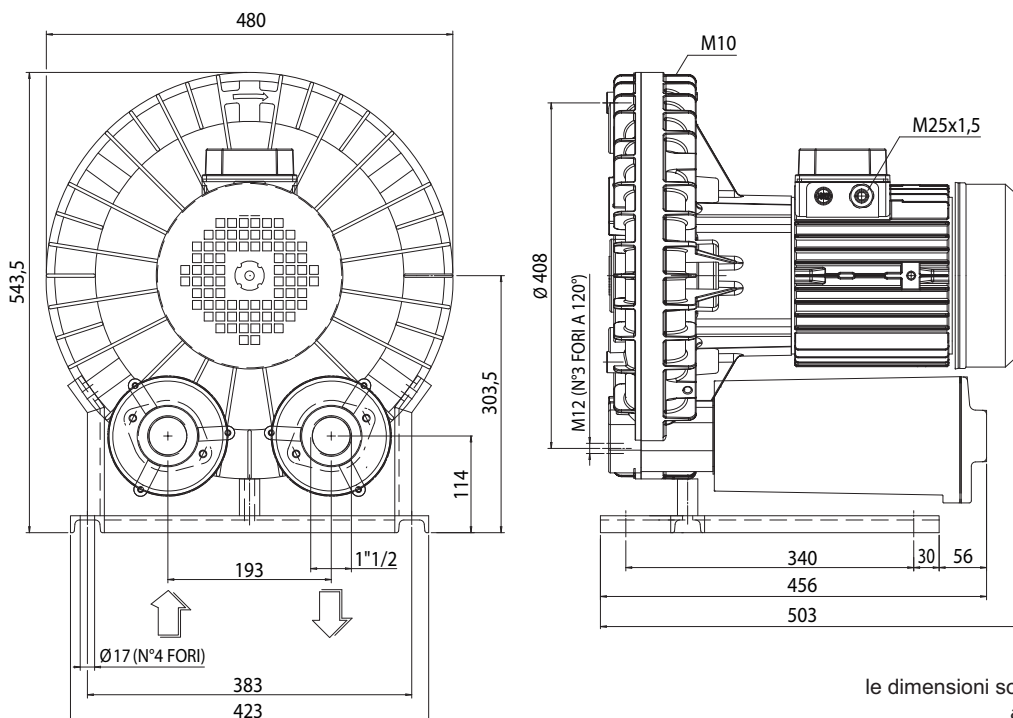

le dimensioni sono espresse in millimetri  
all dimensions are in mm

## ASPIRAZIONE VACUUM

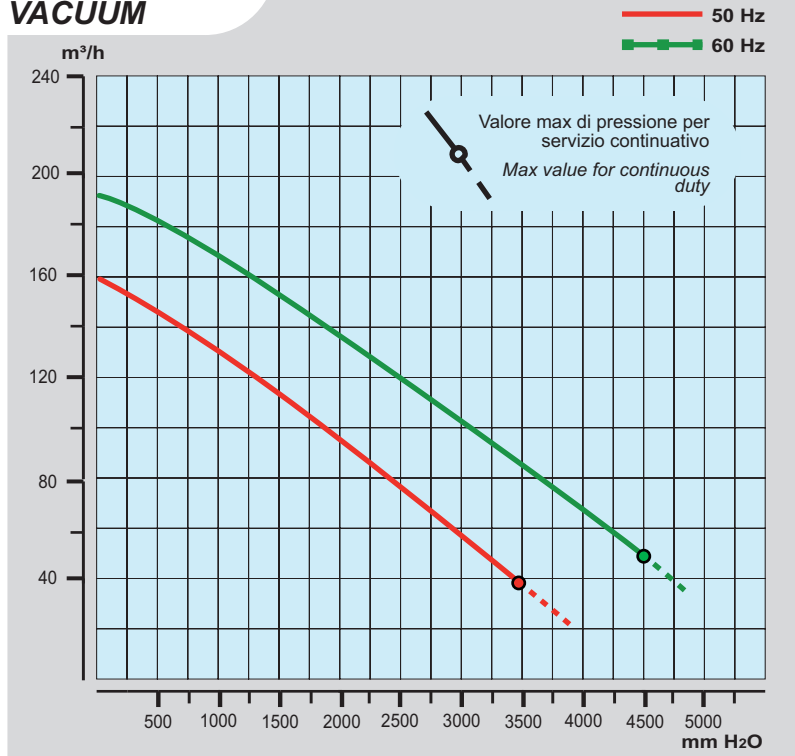

## ASSORBIMENTO MOTORE MOTOR ABSORPTION

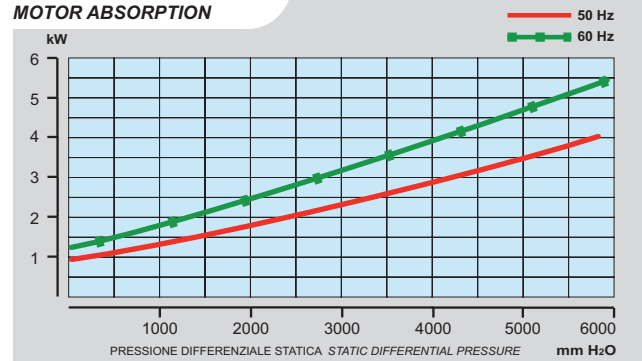

## INCREMENTO TEMPERATURA ARIA AIR TEMPERATURE INCREASE

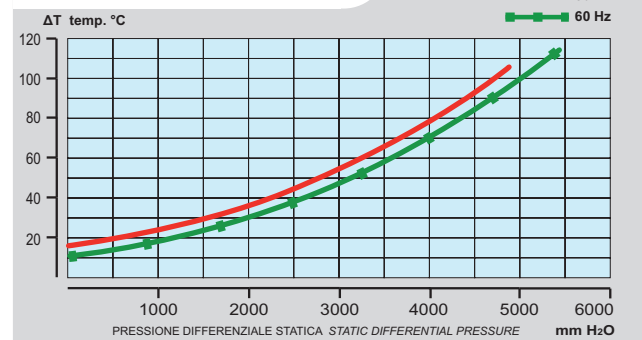

## COMPRESSIONE PRESSURE

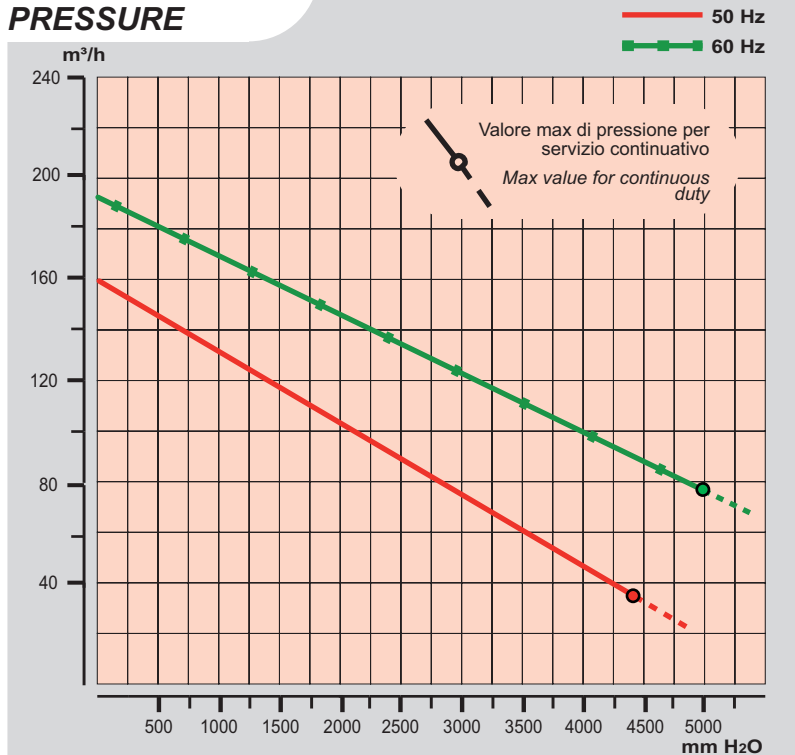

## ASSORBIMENTO MOTORE MOTOR ABSORPTION

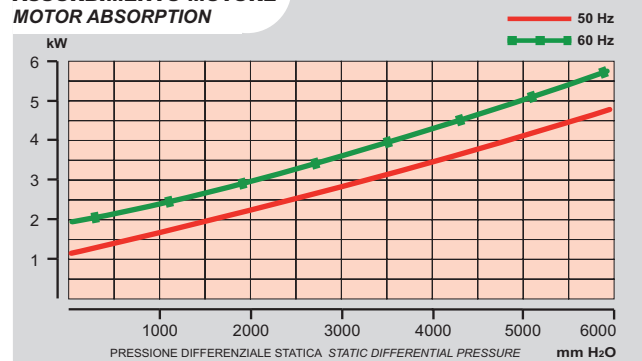

## INCREMENTO TEMPERATURA ARIA AIR TEMPERATURE INCREASE

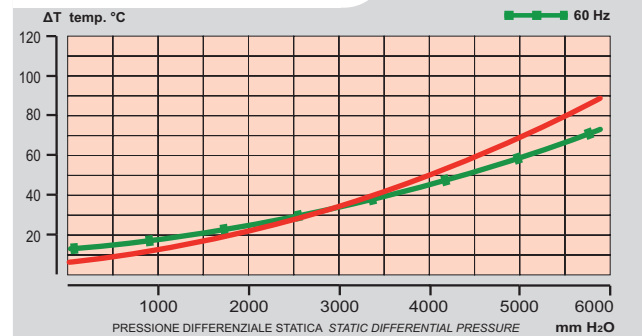

Tutti i dati della presente scheda tecnica si intendono indicativi e potranno essere modificati dalla casa in qualsiasi momento senza nessun preavviso.  
La curva di aspirazione è riferita ad aria alla temperatura media di 20 °C e 1013 mbar sul raccordo di mandata.  
La curva di compressione è riferita ad aria alla temperatura media di 20 °C e 1013 mbar sul raccordo di aspirazione.

All data is intended as an indication and may be modified without prior notice.

The vacuum curve is valid for pumping air, with a temperature of 20°C at the inlet flange and with a pressure of 1013 mbar at the discharge port.

The pressure curve is valid for pumping air, with an average temperature of 20°C and 1013 mbar at the inlet flange.

l/min = m<sup>3</sup>/h · 16,667  
CFM = m<sup>3</sup>/h · 0,588  
mbar = mm H<sub>2</sub>O · 0,098  
PSI = mm H<sub>2</sub>O · 0,00142