

DESCRIPTION

Dutair LK-series industrial ventilators consist of a robust body made from die-cast aluminium alloy. Impellers are made of extruded aluminium. The asynchronous electric motors are maintenance free and provided with long life ball bearings. All models have fully enclosed IP54 motors with a lip seal fitted to the drive shaft. The maximum ambient operating temperature is 40°C and the maximum temperature of the gases to be handled is 80°C.

FEATURES

- all Dutair ventilators can be mounted in any position desired with the exception of the inlet pointing upwards
- the outlet can be rotated in eight positions
- high capacity for narrow ducting
- LK-series provide pressures of up to 14.5 kPa
- suction as well as pressure operation
- low vibration levels
- maintenance free
- many different applications

BENEFITS

- very low noise levels at high performances
- accurate performance curves in a frequency range of 20 to 80 Hz make Dutair fans suitable for applications with a wide operating area
- both suction and pressure performance curves for operation in Nm³/h
- detailed sound level data for acoustic purposes
- a variety of modifications are possible for non-standard applications



GENERAL TECHNICAL DATA

LK803		50 Hz	60 Hz
Power ^①	kW	2.2	2.6
Voltage Δ / Y ^②	V	230/400	265/460
Current Δ / Y	A	8.8/5.1	8.8/5.1
Revolutions	/min	2935	3500
Protection class ^③		IP54	IP54
Efficiency class ^④		IE2	IE1
Efficiency ^⑤	%	84.3	81.8
Power factor	%	75.4	78.2
Sound pressure ^⑥	dB(A)	66.3	70.1
Weight	kg	42.5	42.5

① see notes on page 5

DIMENSIONS

all dimensions in mm, tolerance +/-2 mm

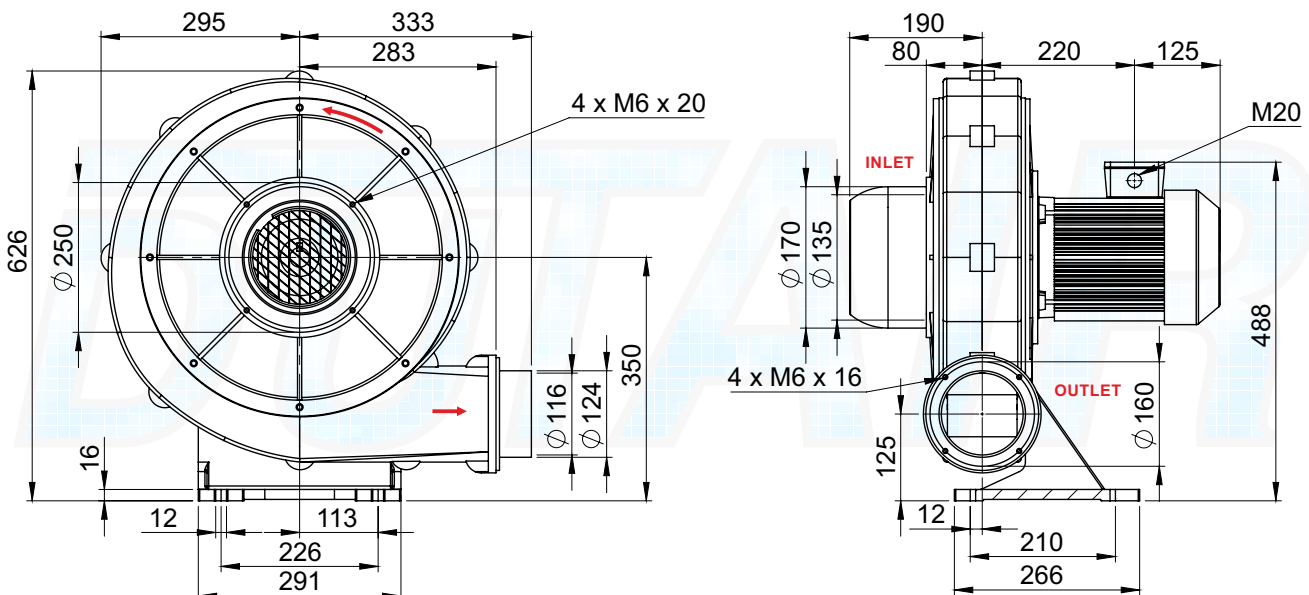

- CAD models available in STEP format
- in case of discrepancy between dimensional drawing and CAD model, dimensions in dimensional drawing take precedence

PERFORMANCE

Total pressure difference between inlet and outlet Δp_i against airflow Q at an ambient condition of 1013 mbar and 20 °C. All duty points on characteristics curves are in thermal equilibrium[Ⓢ]. Flow is rated in Nm³/h defined as air, 1013 mbar and 0 °C. Tolerance +/-3%. See notes on page 7.

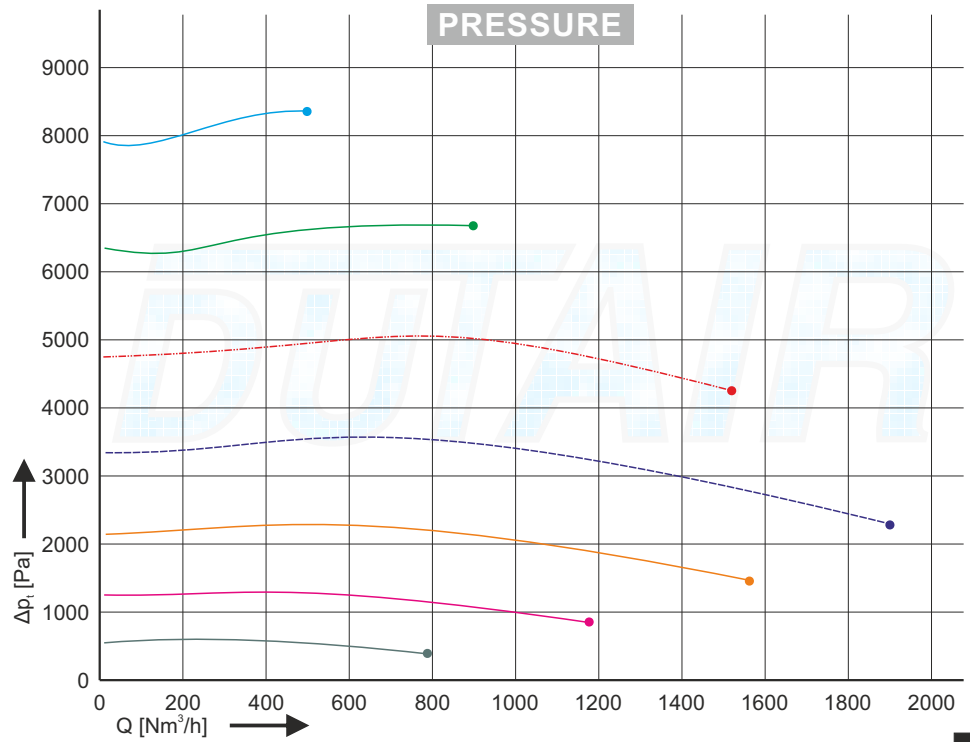
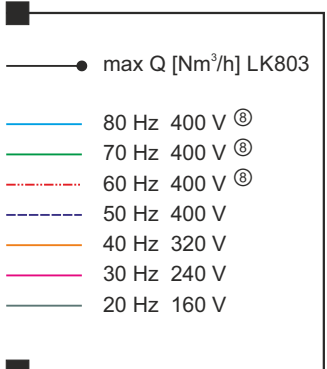

POWER

Motor power P delivered at impeller shaft. Ambient condition of 1013 mbar and 20 °C. All duty points on characteristics curves are in thermal equilibrium[Ⓢ]. Tolerance +/-5%. Accurate data on current consumption for specific duty points available on request.

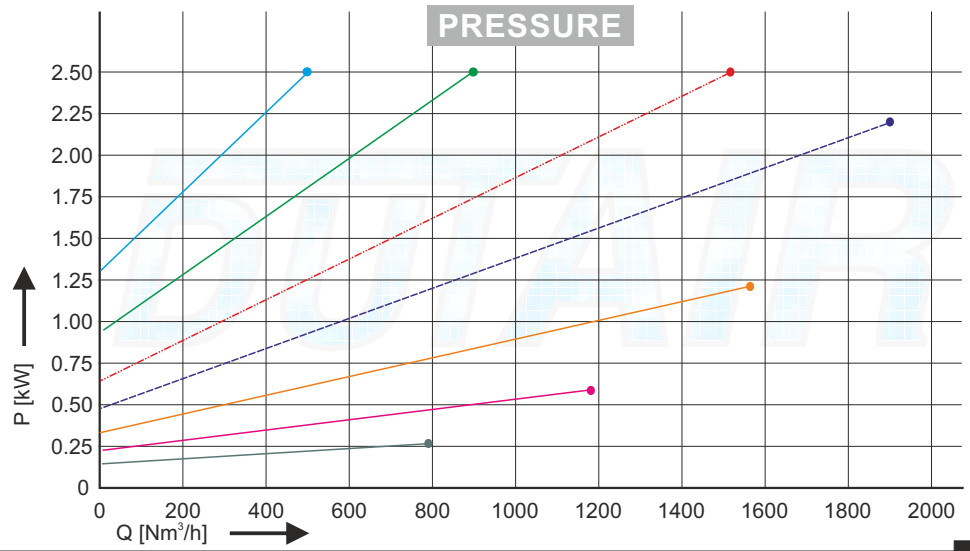

PERFORMANCE

Total pressure difference between inlet and outlet Δp_i against airflow Q at an ambient condition of 1013 mbar and 20 °C. All duty points on characteristics curves are in thermal equilibrium[Ⓢ]. Flow is rated in Nm³/h defined as air, 1013 mbar and 0 °C. Tolerance +/-3%. See notes on page 7.

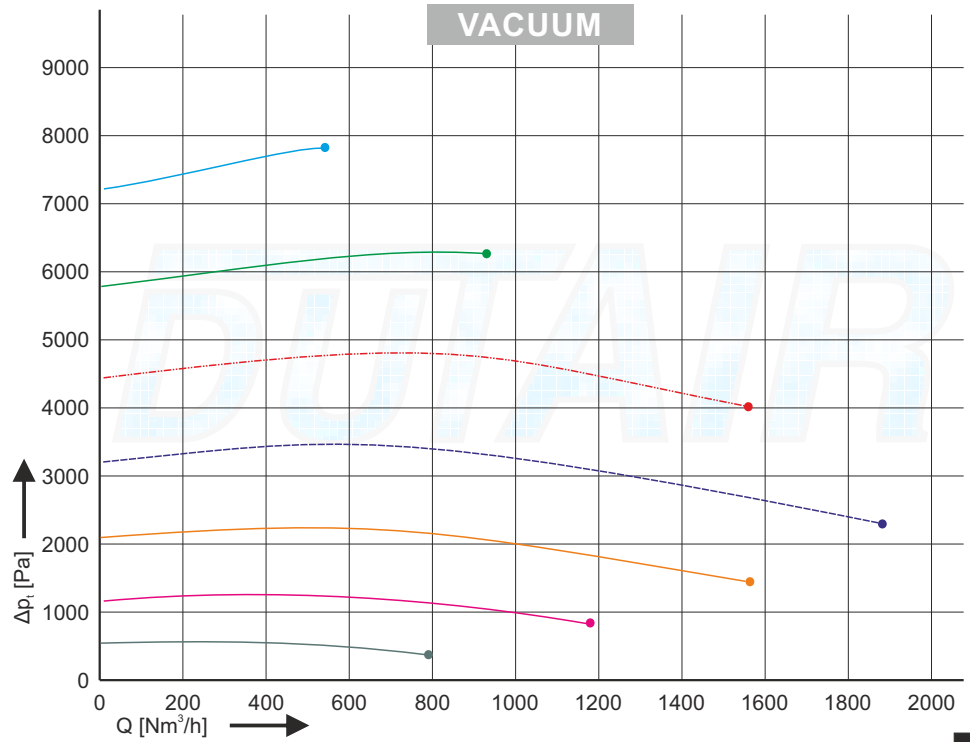
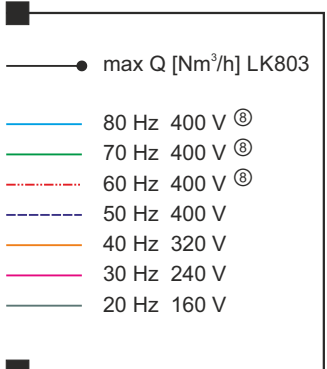

POWER

Motor power P delivered at impeller shaft. Ambient condition of 1013 mbar and 20 °C. All duty points on characteristics curves are in thermal equilibrium[Ⓢ]. Tolerance +/-5%. Accurate data on current consumption for specific duty points available on request.

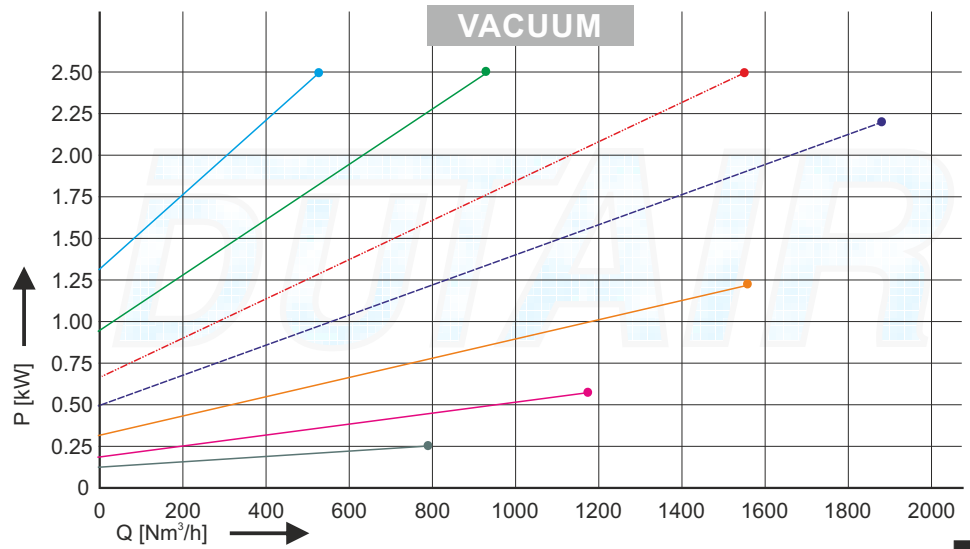

SOUND LEVEL PRESSURE LK803

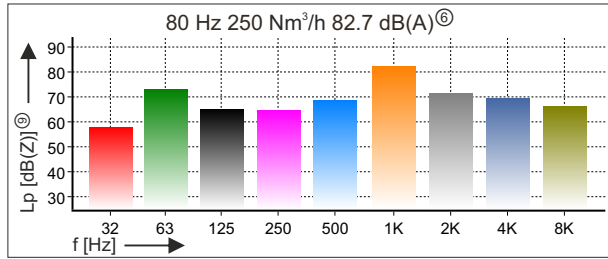
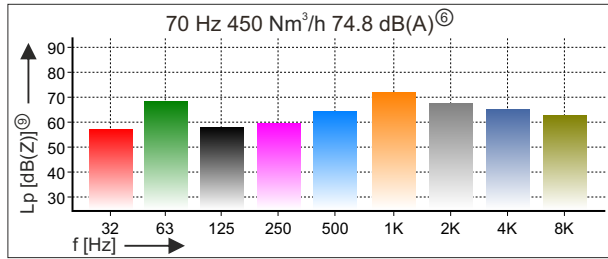
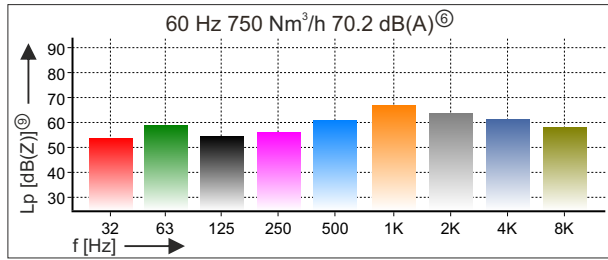
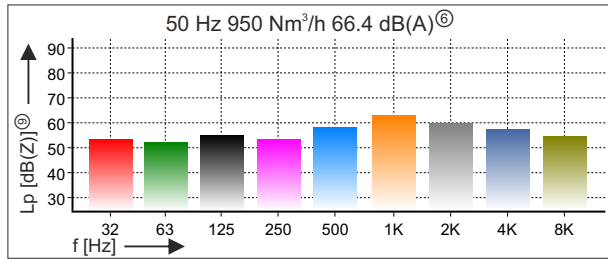
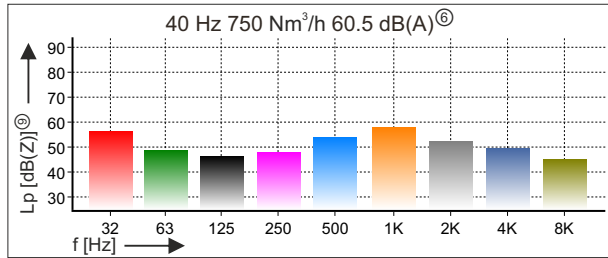
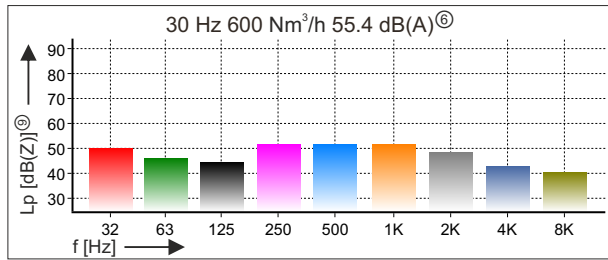
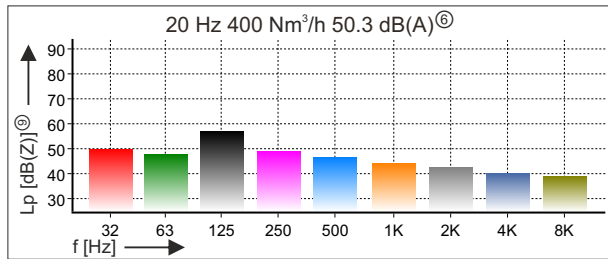

SOUND LEVEL VACUUM LK803

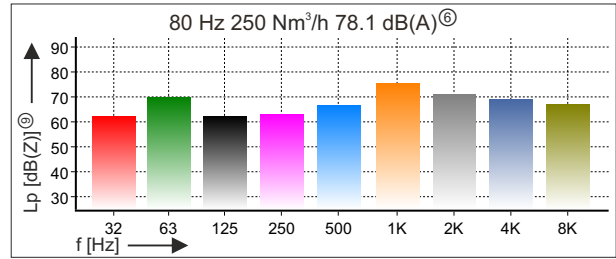
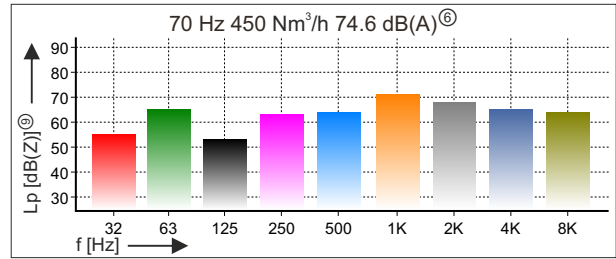
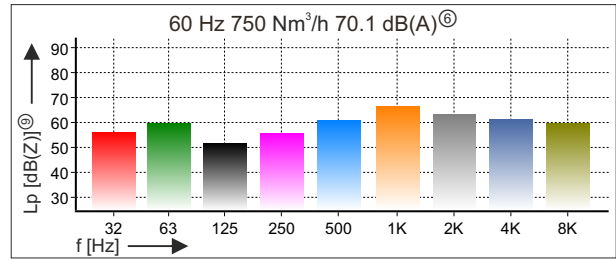
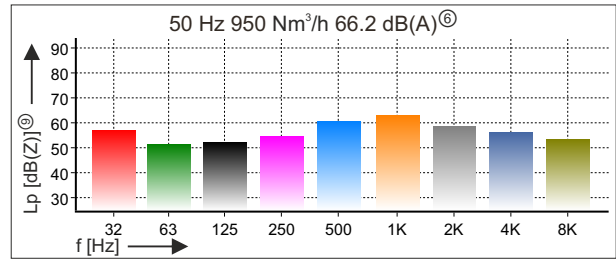
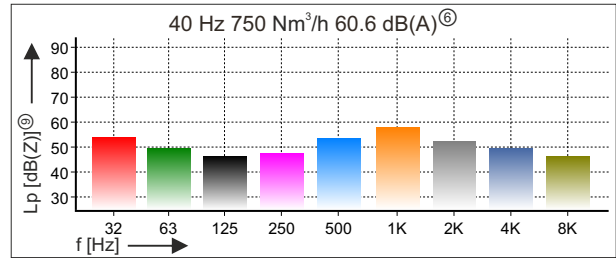
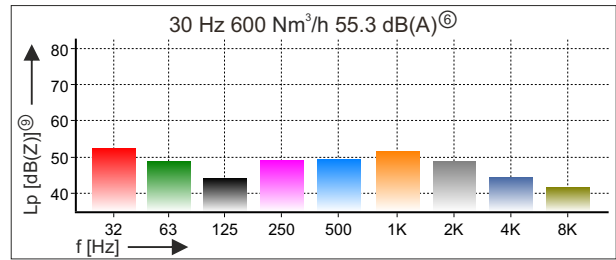
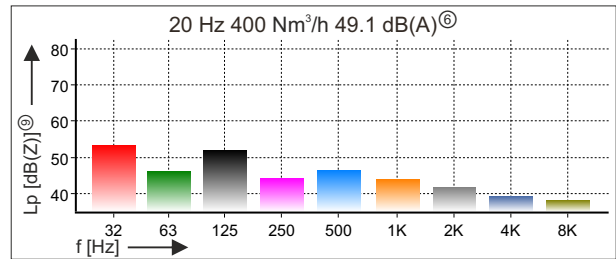

ORDERING INFORMATION

53	LK	801	RD	270	U...-.	ss	HT	RS	IP56	Q	C...	PTC
51: single phase / 53: three phase	Model centrifugal fan	Model size	RD: Clockwise rotation sense	Pumphouse orientation angle	Optional special motor voltage e.g. U500-50: 500 V at 50 Hz version	Optional bearing material ss: stainless steel	Optional bearing lubrication ^⑩ HT: high temp. / LT: low temp.	Optional bearing material RS: Improved resistance against moisture	Optional motor protection: IP56 / IP65, for IP56 specific mounting position	Optional Q: anti condensation heating 230 V	Optional painting, standard RAL 7023 e.g. C7035: RAL 7035	Optional 3-piece PTC thermistors fitted in series in each motor phase

COMMENTS

WARNING: Comparing performance data can be misleading. Dutair specifications are based on a thermal equilibrium^⑦ for all duty points along the characteristics curves in this document. Many commercial based flow characteristics curves defined as m³/h air at 20 °C, 1013 mbar(a) and +/-10 % tolerance but can be up to 20 % higher than accurate characteristics curves defined as Nm³/h air at 0 °C, 1013 mbar(a), thermal equilibrium^⑦ duty points and +/-3 % tolerance as specified in this Dutair document.

The performance measurements are executed with instruments calibrated by DNV KEMA and are traceable to primary and/or internationally accepted measurement standards.

- ① Maximum shaft power allowed at continuous operation.
Rated output electric motor in accordance with NEN-EN-IEC 60034-1.
- ② Rated voltage for three phase triangle and star connection. Allowed supply voltage tolerance 5 %.
Consult your Dutair dealer for different supply voltages.
- ③ Protection class in accordance with NEN-EN-IEC 60034-5.
- ④ Efficiency classification in accordance with NEN-EN-IEC 60034-30.
- ⑤ Efficiency rated at 100% motor load.
- ⑥ Free field equivalent continuous sound pressure level A-weighted L_{eq}[dB(A)].
Unless specified L_{eq}[dB(A)] rated at 50 % of maximum flow at 50 Hz. Tolerance +/- 2 dB(A).
Conditions as note ^⑩.
- ⑦ Thermal equilibrium is the state reached when the temperature rises of several parts of the machine as well as the temperature rise between in- and outlet do not vary by more than a gradient of 2°C per hour.
- ⑧ Operation at 400 V within range of 60 to 80 Hz: 110 % of rated current at 50 Hz is allowed for 60 Hz power rating.
- ⑨ Free field class 1 octave band measurements in accordance with IEC 61260 unweighted L_p[dB(Z)].
Tolerance +/- 5 dB(Z). Conditions as note ^⑩.
- ⑩ Measurements at 1 m distance with in- and outlet duct connected to the fan on a reflective surface.
Class 1 sound level meter Delta Ohm HD2010UC/A according to IEC 61672-1.
Acoustic calibration prior to measurements with class 1 calibrator HD2020ACC according to IEC 60942.
- ⑪ Standard ambient temperature range -20...+40°C.