



UNI-JET 75 2V

0,7 - 0,75 kW (50 Hz)

0,9 kW (60 Hz)

Del presente modello sono disponibili anche le seguenti versioni speciali:

This model is also available with the following specifications:

- **LUBRIFICATO** per alte temperature / **LHT** Lubricated for high temperature
- a richiesta **TENSIONI SPECIALI** / **SPECIAL VOLTAGES** on request

MOTORI COSTRUITI SECONDO LE NORME CEI 2-3 (1988) ISOL. CL F PROT. IP 54
MOTORS CONSTRUCTION CONFORM WITH CEI 2-3 (1988) NORMS. ISOL. CL F PROT. IP 54

ARTICOLO ITEM CODE	kW	V	Hz	assorb. AMP. absorbed. AMPS.	giri/min r.p.m.	LIMITE SERVIZIO MAX CONT. DUTY S1 mmH ₂ O	μF/V	dB (A)*	PESO Kg WEIGHT Kg	
MONO-FASE	019120	0,7	230	50	4,8	2820	-2750 +2500	20/450	64	16
TRIFASE	019130	0,75	230 Δ	50	3,4	2850	-2750 +2500	64	16	
			400 Y	50	1,95					
	0,9	265 Δ	60	3,4	3450	-2500 +2350	68	16		
		460 Y	60	1,95						

* Livello di pressione sonora rilevato secondo le Norme ISO 3746 - 1979 (E). Parametri: r=1 - Rumore di fondo ≤ 51 dB (A) - Strumento: Brüel & Kjær type 2232.
* Sound pressure level tested according to ISO regulation 3746 - 1979 (E). Parameters: r=1 - Background noise ≤ 51 dB (A) - Instrument: Brüel & Kjær type 2232.

DIMENSIONI DIMENSIONS

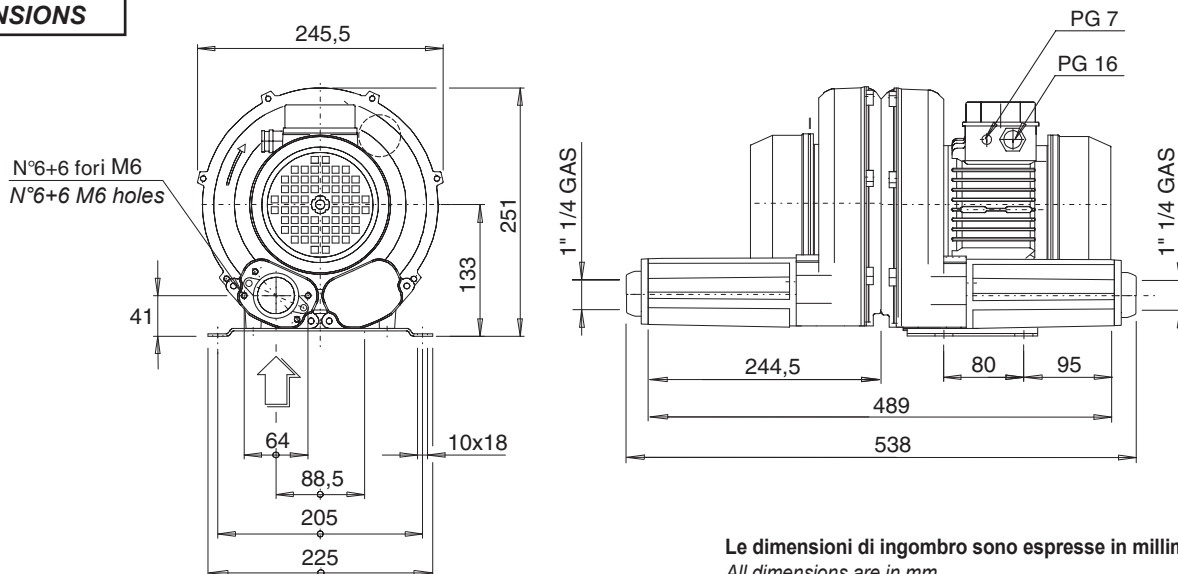

Le dimensioni di ingombro sono espresse in millimetri
All dimensions are in mm.



esam

UNI-JET 75 2V

0,7 - 0,75 kW (50 Hz)
0,9 kW (60 Hz)

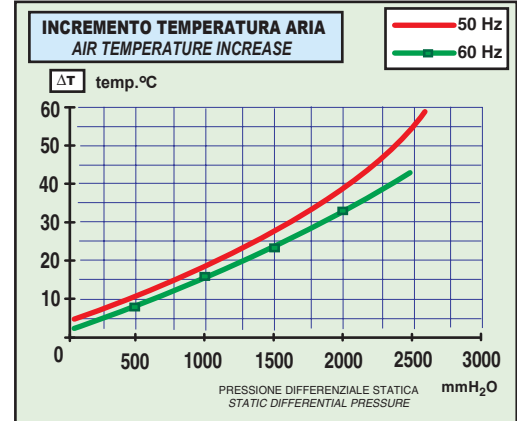
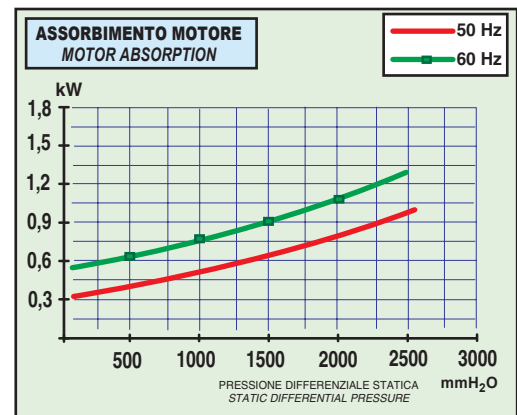
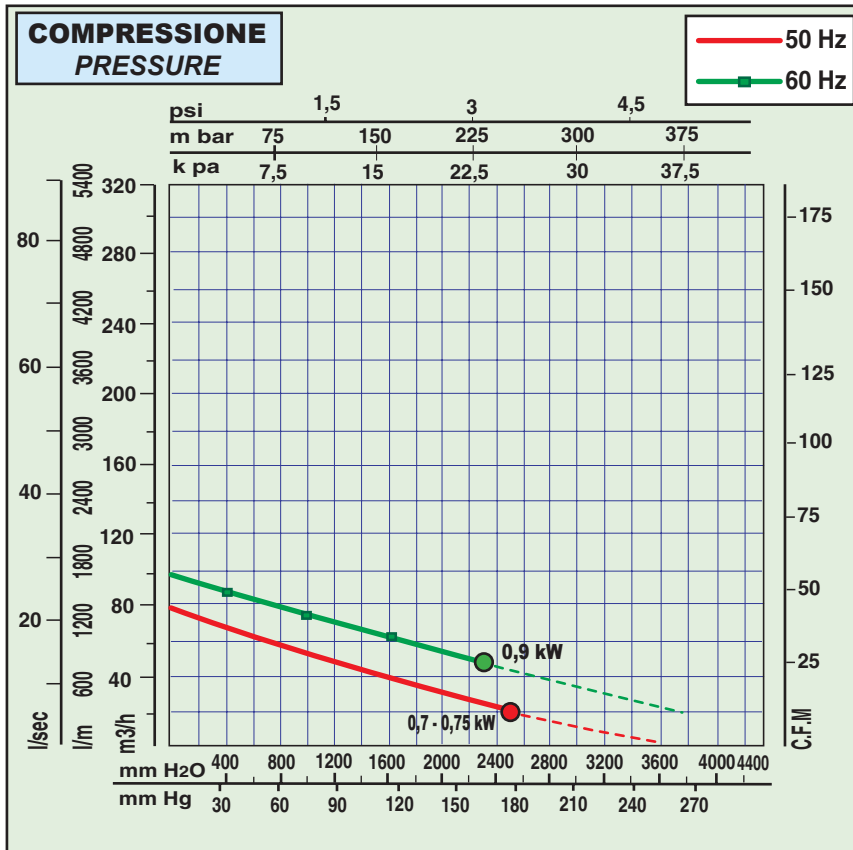
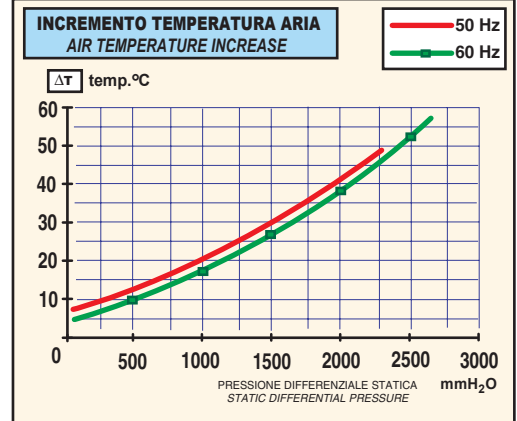
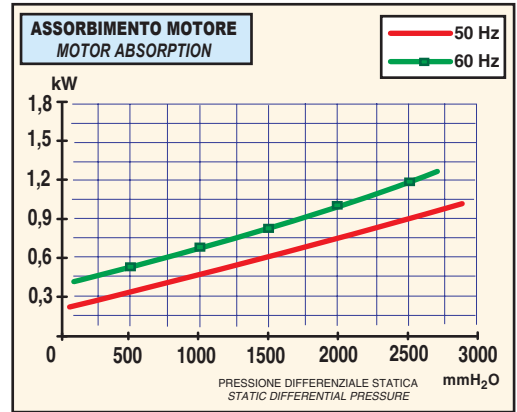
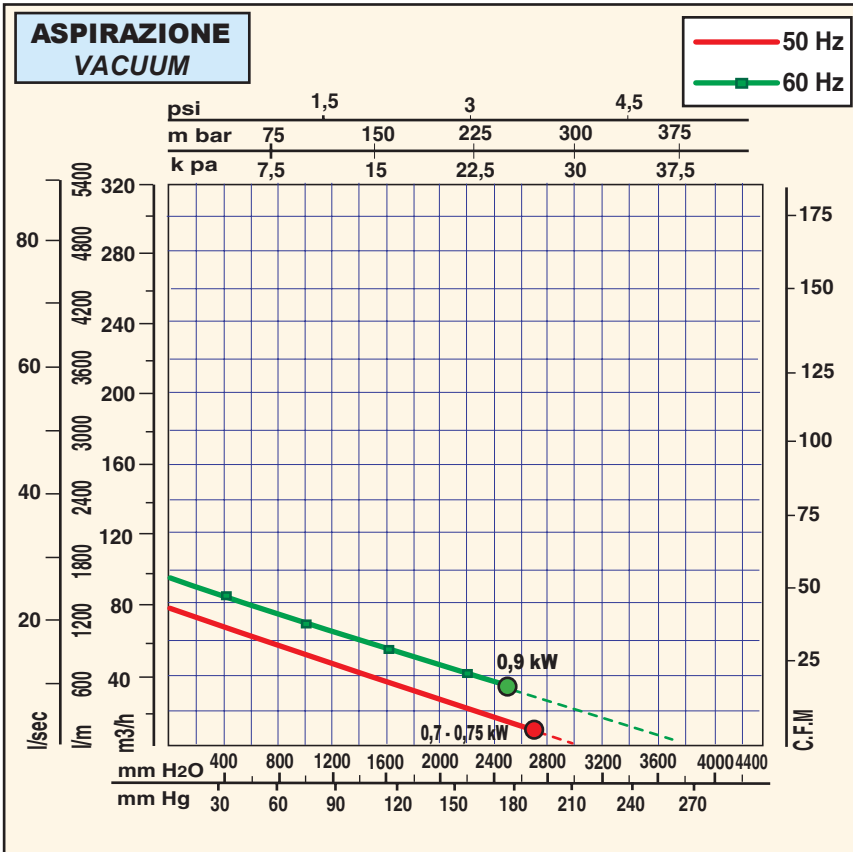

Tutti i dati della presente scheda tecnica si intendono indicativi e potranno essere modificati dalla casa in qualsiasi momento senza nessun preavviso.
 La curva di aspirazione è riferita ad aria alla temperatura media di 20 °C e 1013 mbar sul raccordo di mandata.
 La curva di compressione è riferita ad aria alla temperatura media di 20 °C e 1013 mbar sul raccordo di aspirazione.
 All data is intended as an indication and may be modified without prior notice.
 The vacuum curve is valid for pumping air, with a temperature of 20°C at the inlet flange and with a pressure of 1013 mbar at the discharge port.
 The pressure curve is valid for pumping air, with an average temperature of 20°C and 1013 mbar at the inlet flange.

Valore max di pressione per servizio continuativo
 Max value for continuous duty

1~ MonoFase / Single Phase
 3~ TriFase / Three Phase