

UNI-JET 500

7,5 - 9 - 11 - 13,7 kW (50 Hz)
8,6 - 10,4 - 12,6 - 15,5 kW (60 Hz)

Del presente modello sono disponibili anche le seguenti versioni speciali:

This model is also available with the following specifications:

- **ANTIDEFLAGRANTE / FLAME PROOF / EXPLOSION PROOF**

- **ANODIZZATO / ANODIZED TREATMENT**

- a richiesta **TENSIONI SPECIALI / SPECIAL VOLTAGES on request**

MOTORI COSTRUITI SECONDO LE NORME CEI 2-3 (1988) ISOL. CL F PROT. IP 54

MOTORS CONSTRUCTION CONFORM WITH CEI 2-3 (1988) NORMS. ISOL. CL F PROT. IP 54

ARTICOLO ITEM CODE	kW	V	Hz	assorb. AMP. absorbed. AMPS.	giri/min r.p.m.	LIMITE SERVIZIO MAX CONT. DUTY S1 mmH ₂ O	μF/V	dB (A)*	PESO Kg WEIGHT Kg
T R I P H A S E	080006	7,5	400 Δ	50	15	2900	-3250 +3000	78	88
			690 Y	50	8,7				
		8,6	460 Δ	60	14,3	3500	-2750 +2500	80	88
			795 Y	60	8,3				
	080009	9	400 Δ	50	19	2900	-3500 +3750	78	102
			690 Y	50	11				
		10,4	460 Δ	60	17,6	3500	-3500 +3000	80	102
			795 Y	60	10,2				
	080011	11	400 Δ	50	22,5	2880	-3750 +4500	78	104
			690 Y	50	13				
		12,6	460 Δ	60	22	3500	-3750 +4250	80	104
			795 Y	60	12,7				
080016	13,7	400 Δ	50	27	2900	-4000 +5250	78	112	
		690 Y	50	15,6					
	15,5	460 Δ	60	27	3500	-4250 +5000	80	112	
		795 Y	60	15,6					

* Livello di pressione sonora rilevato secondo le Norme ISO 3746 - 1979 (E). Parametri: r=1 - Rumore di fondo ≤ 51 dB (A) - Strumento: Brüel & Kjær type 2232.

* Sound pressure level tested according to ISO regulation 3746 - 1979 (E). Parameters: r=1 - Background noise ≤ 51 dB (A) - Instrument: Brüel & Kjær type 2232.

DIMENSIONI DIMENSIONS

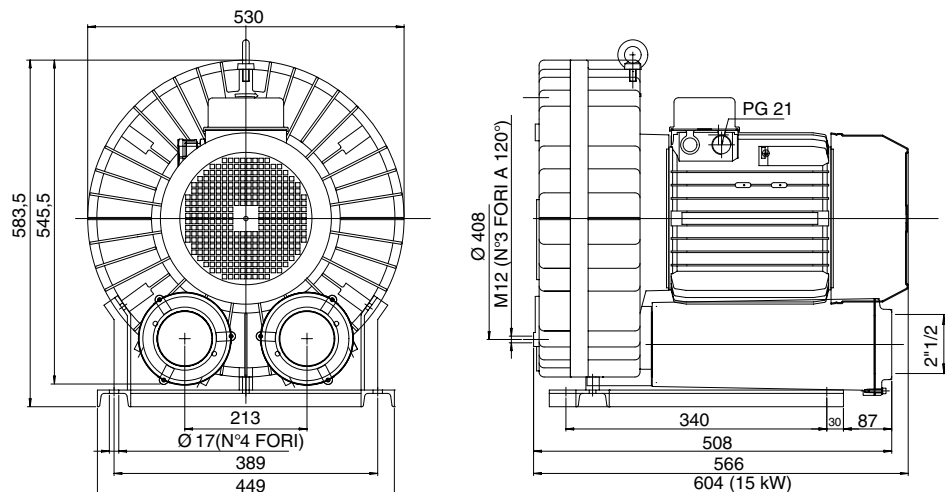

Le dimensioni di ingombro sono espresse in millimetri
 All dimensions are in mm.



UNI-JET 500

7,5 - 9 - 11 - 13,7 kW (50 Hz)
8,6 - 10,4 - 12,6 - 15,5 kW (60 Hz)

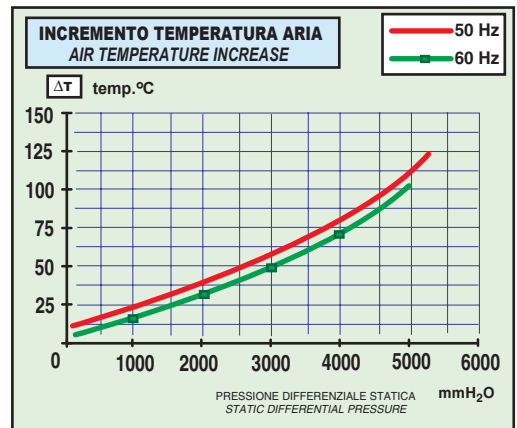
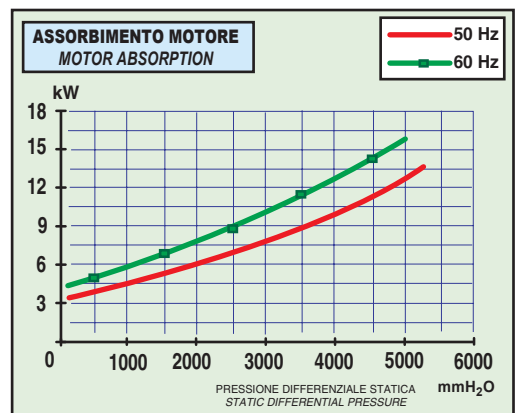
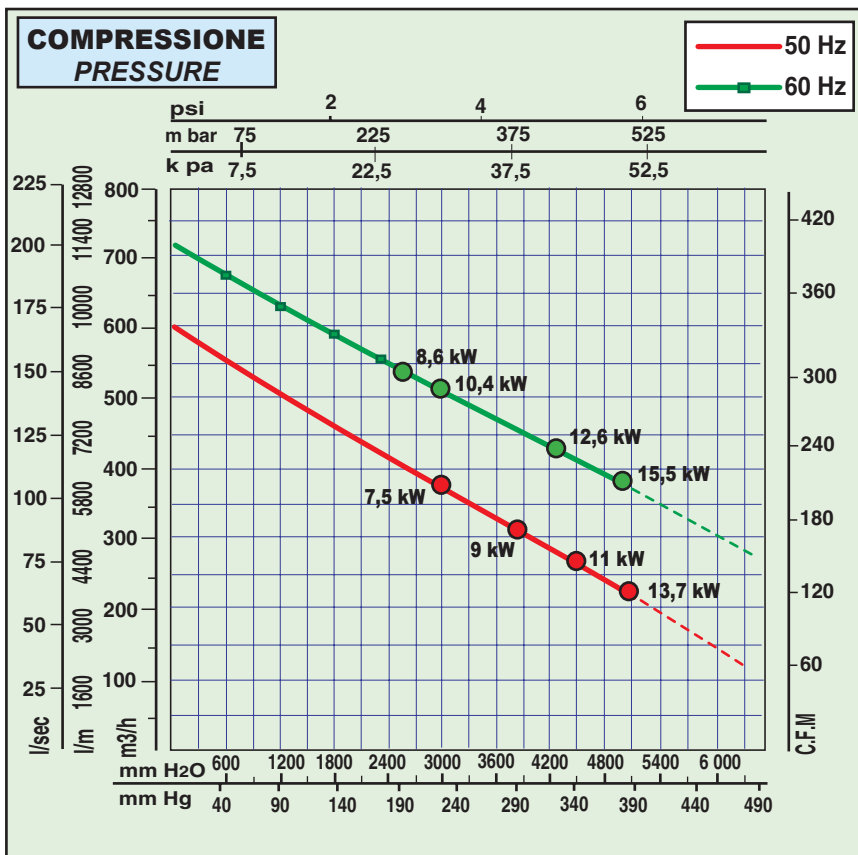
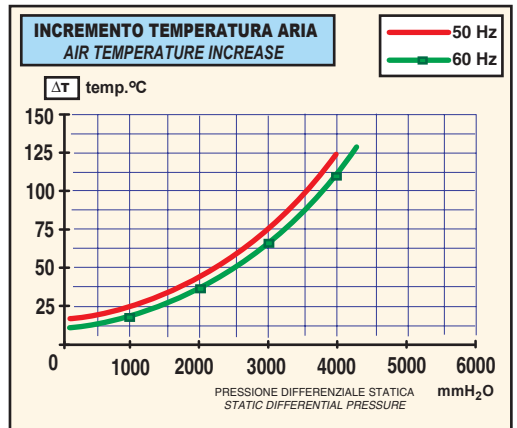
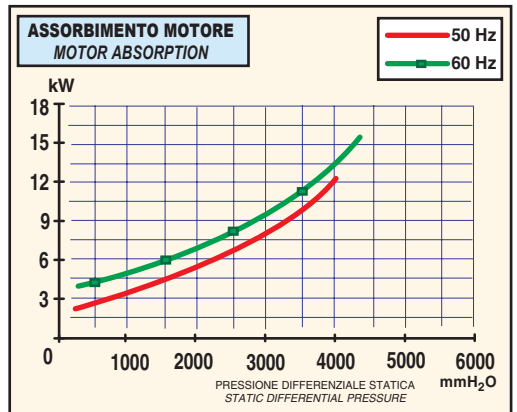
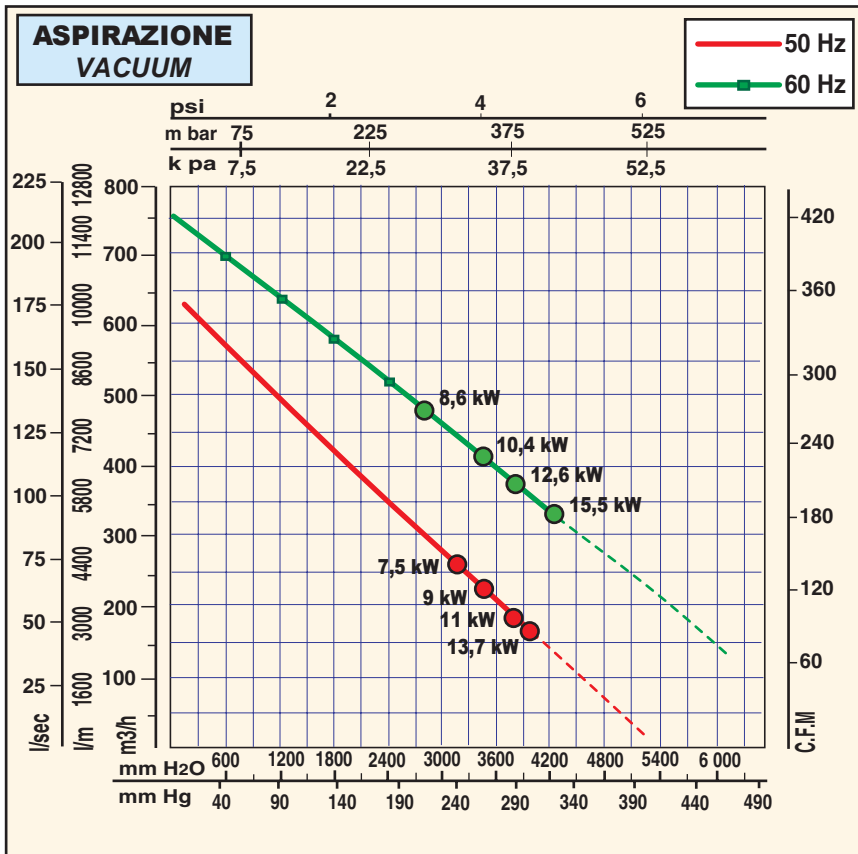

Tutti i dati della presente scheda tecnica si intendono indicativi e potranno essere modificati dalla casa in qualsiasi momento senza nessun preavviso.
 La curva di aspirazione è riferita ad aria alla temperatura media di 20 °C e 1013 mbar sul raccordo di mandata.
 La curva di compressione è riferita ad aria alla temperatura media di 20 °C e 1013 mbar sul raccordo di aspirazione.
 All data is intended as an indication and may be modified without prior notice.
 The vacuum curve is valid for pumping air, with a temperature of 20°C at the inlet flange and with a pressure of 1013 mbar at the discharge port.
 The pressure curve is valid for pumping air, with an average temperature of 20°C and 1013 mbar at the inlet flange.

Valore max di pressione per servizio continuativo
 Max value for continuous duty