

General

Model: centrifugal ventilator.
The robust ventilator body and impeller are made of die-cast aluminium alloy and are coated. Asynchronous motor fitted with long-life ball bearings.

Application

Suitable for transport of clean and dusty gasses without abrasive particles and with a temperature limited to 80°C.

Algemeen

Type: centrifugaalventilator.
Het robuuste ventilatorhuis en de waaier zijn gemaakt uit gietaluminium en voorzien van een solide coating. De asynchrone motor is voorzien van duurzame kogellagers.

Toepassing

Inzetbaar voor transport van schone en vervuilde gassen, zonder schurende stoffen, met een maximum temperatuur van 80°C.



Technical data

Power	Vermogen	0.05	kW
Voltage 1~	Spanning 1~	230	V
3~	3~	230/400	V
Current 1~	Stroom 1~	1.2	A
3~	3~	0.5/0.28	A
Frequency	Frequentie	50	Hz
Revolutions	Toerental	2800	/min
Protection class	Bescherming	IP 20	
Noise level	Geluidsniveau	50	dB
Weight	Gewicht	4.3	kg

Technische gegevens

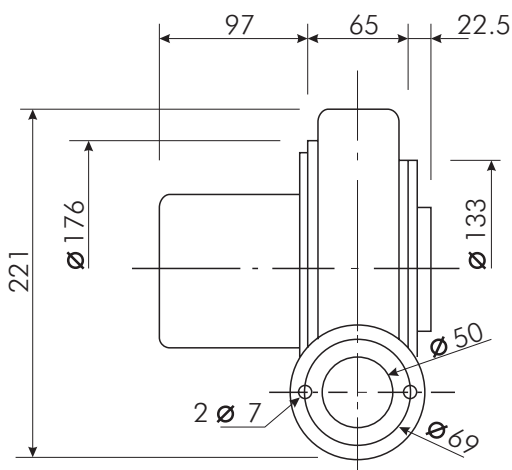
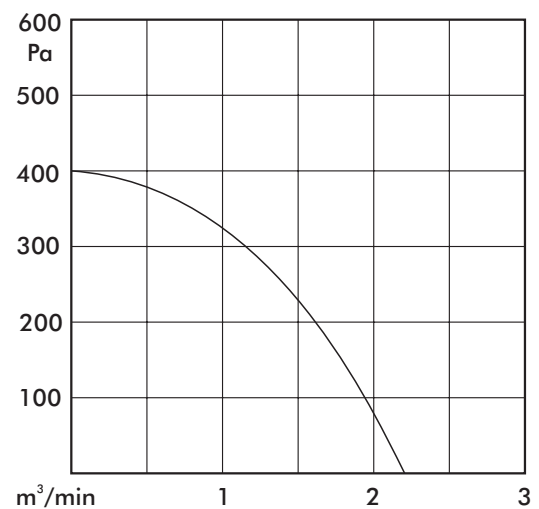

Dimensions in mm

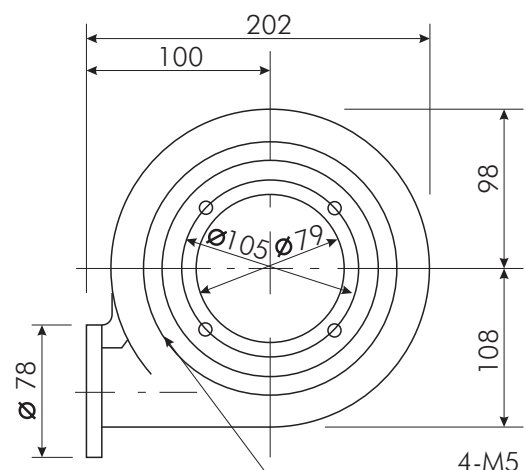

Maten in mm